

Sterically Crowded Stable Simple Enols[†]

ZVI RAPPOPORT* and SILVIO E. BIALI

Department of Organic Chemistry, The Hebrew University of Jerusalem, Jerusalem 91904, Israel

Received June 1, 1988 (Revised Manuscript Received August 8, 1988)

Beginning of a Research Project

Our interest in stable enols began in a rather indirect way. During our studies on solvolytically generated triarylvinyl cations from triarylvinyl bromides and tosylates we found that the k_{OTs}/k_{Br} reactivity ratios decreased, while the selectivity of the derived cation to capture by Br^- vs capture by the solvent increased on increasing the bulk of the β -aryl group.¹ We attempted to obtain more sterically hindered precursors for more selective and expectedly longer-lived vinyl cations by extending our synthetic scheme, which consisted of addition of bromine to a crowded triarylethylene, followed by a base-catalyzed dehydrohalogenation. We failed completely when electron-donating or bulky aryl groups were present² since either bromination of the aryl rings instead of the shielded double bond took place or the base treatment of the crowded 1,1,2-triaryl-1,2-dibromoethane led to dehalogenation rather than to the desired dehydrohalogenation.² We reasoned that an alternative approach is to create a functionalized triarylvinyl system in which the functionality can be converted to a leaving group via derivatization. Furthermore, a functionality that could be easily labeled with ¹⁸O seemed beneficial for mechanistic solvolysis studies. Searching the literature for potential candidates, we came across a remarkable family of compounds that did fulfill our needs: Fuson's sterically crowded stable simple enols.

Fuson's Stable Simple Enols

"Simple" enols, defined as those in which the double-bond substituents are hydrogen, alkyl, or aryl groups, are usually kinetically and thermodynamically unstable compared with their keto forms. Remarkable progress in the synthesis of simple enols in recent years was achieved by Capon's³ and Kresge's⁴ groups, but the enols are still kinetically unstable and rapidly tautomerize to their carbonyl isomers. It is therefore noteworthy that several decades ago Fuson, in a series of classic papers, demonstrated that sterically hindered enols such as 1, 2, and 3 are "stable" (isolable) if poly-substituted by bulky (e.g., mesityl (Mes = 2,4,6-Me₃C₆H₂)) aryl groups.⁵ Two of the enols prepared, i.e., trimesitylethenol^{6a} (1) and 2,2-dimesitylethenol^{6b-d} (2), showed extraordinary stability since all attempts to ketonize them to 4 and 5 had failed. For example,

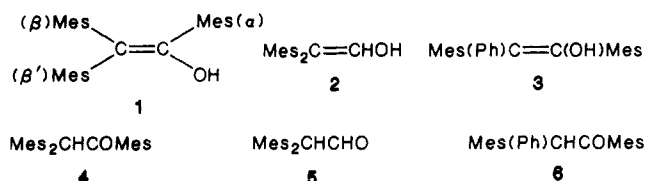

treatment of 2 with HCl in alcohol gave the enol ether rather than 5, and it was stated that "there is, in particular no evidence of the presence of the aldehyde in the solution of the enol".^{6c} Moreover, all attempts to synthesize 1,2,2-trimesitylethanone (4) (the keto isomer of 1) failed. When the steric crowding was reduced, both the keto and enol forms could be synthesized as in the case of 1,2-dimesityl-2-phenylethenol (3) and its keto form (6).

Most of Fuson's work preceded the advent of spectroscopic methods, and the structural characterization of the enols was indirect (e.g., derivatization, degradation, or ketonization); only in his later papers were some spectroscopic data presented.⁷ From the large number of attempts to synthesize enols, Fuson concluded that a necessary but not always sufficient condition to render the enols stable is their substitution by at least two bulky aryl groups. Although it was clear that the enols were kinetically stable, direct evidence that they were thermodynamically more stable than their keto forms was not given. Unaccountably, Fuson's enols were neglected in most textbooks and reviews, and only isolated studies were later carried out on them and related compounds.⁸ When in a 1979 review Hart stated "A systematic study of their chemistry has never been undertaken and might be worthwhile",⁵ we were already in the first stage of our study.

Mechanistic Potential of Stable Simple Enols

The relatively simple synthesis of the crowded simple enols seemed an attractive way to prepare the solvolytic

[†] Dedicated to Professor Saul Patai on occasion of his 70th birthday.

(1) (a) Stang, P. J.; Rappoport, Z.; Hanack, M.; Subramanian, L. R. *Vinyl Cations*; Academic Press: San Francisco, 1979; Chapter 6. (b) For a recent review on vinyl cations, see: Rappoport, Z. In *Reactive Intermediates*; Abramovitch, R. A., Ed.; Plenum: New York, 1983; Vol. 3, pp 427-615.

(2) Rappoport, Z.; Apeloig, Y.; Greenblatt, J. *J. Am. Chem. Soc.* **1980**, *102*, 3837.

(3) For a recent review, see: Capon, B.; Guo, B.-Z.; Kwok, F. C.; Siddhanta, A. K.; Zucco, C. *Acc. Chem. Res.* **1988**, *21*, 135.

(4) Chiang, Y.; Kresge, A. J.; Krogh, E. T. *J. Am. Chem. Soc.* **1988**, *110*, 2600 and references therein.

(5) For a review on stable enols (including Fuson's enols), see: Hart, H. *Chem. Rev.* **1979**, *79*, 515.

(6) (a) Fuson, R. C.; Chadwick, D. H.; Ward, M. L. *J. Am. Chem. Soc.* **1946**, *68*, 389. (b) Fuson, R. C.; Rowland, S. P. *Ibid.* **1943**, *65*, 992. (c) Fuson, R. C.; Southwick, P. L.; Rowland, S. P. *Ibid.* **1944**, *66*, 1109. (d) Fuson, R. C.; Forster, R. E.; Shenk, W. J.; Maynert, E. W. *Ibid.* **1945**, *67*, 1937.

(7) (a) Fuson, R. C.; Maynert, E. W.; Tan, T. L.; Trumbull, E. R.; Wassmundt, F. W. *J. Am. Chem. Soc.* **1957**, *79*, 1938. (b) Rodebush, W. H.; Feldman, I. *Ibid.* **1946**, *68*, 896. (c) Buswell, A. M.; Rodebush, W. H.; Whitney, R. McL. *Ibid.* **1947**, *69*, 770.

(8) (a) Miller, A. R. *J. Org. Chem.* **1976**, *41*, 3599. (b) Bailey, P. S.; Ward, J. W.; Hornish, R. E.; Potts, F. E. *Adv. Chem. Ser.* **1972**, *No. 112*, 1. (c) Bailey, P. S.; Ward, J. W.; Potts, F. E.; Chang, Y. G.; Hornish, R. E. *J. Am. Chem. Soc.* **1974**, *96*, 7228.

Zvi Rappoport is Esther and Mark Watkins Professor of Organic Chemistry at The Hebrew University of Jerusalem. He was born in Jerusalem in 1936, and received both M.Sc. and Ph.D. degrees at The Hebrew University, followed by 2 years of postdoctoral research at UCLA with the late Saul Winstein. His research interests are in nucleophilic vinylic reactions and vinyl cations (the subjects of previous *Accounts of Chemical Research* articles), solvent effects, reactivity and selectivity, and stable enols. He is a collector of Holy Land and chemistry stamps.

Silvio Biali was born in Buenos Aires in 1957. He received B.Sc. and Ph.D. degrees at The Hebrew University of Jerusalem. After spending 2 years of postdoctoral research with Kurt Mislow at Princeton University, he returned to The Hebrew University, where he is currently Lecturer in the Department of Organic Chemistry.

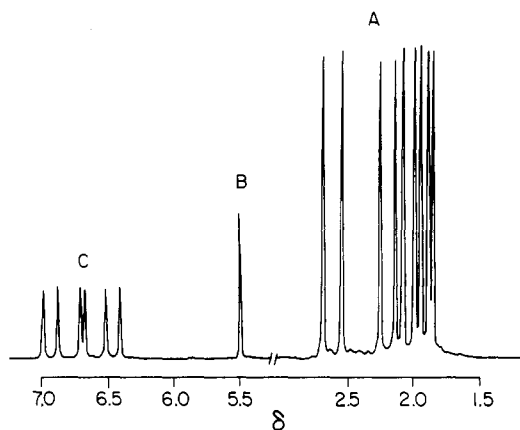

Figure 1. ^1H 300-MHz NMR spectrum of 1 in $\text{C}_6\text{D}_6\text{NO}_2$ at room temperature: (A) Me group region; (B) OH group; (C) aromatic region.

precursors for crowded vinyl cations. However, a glimpse at the ^1H NMR spectrum of 1 (Figure 1) resulted in the realization that these enols are interesting in their own right. We decided to look more closely at these puzzling compounds, and what began as a short detour in our vinyl cation path soon became a main excursion.

The availability of both crowded enol and keto species opened the road to diverse studies of their structures, properties, and reactions and enabled us to deal with problems that are difficult to tackle otherwise. We felt that regardless of whether the crowded enols can serve as models for simple aliphatic enols these remarkable systems deserve study. The properties of the enols that we studied belong to two groups: (a) properties related to the enol functionality such as the gas-phase behavior under ionizing conditions, the solution chemistry of the enols, including their conformation, association with solvents, and isomerization to their keto analogues, and their solid-state structures; and (b) properties related to the presence of the crowded diaryl- or the triarylvinylic skeleton that are not unique to the enol moiety and where the OH group serves as a substituent or as a probe. These include unusual rearrangements in the gas phase, rotational barriers, and steric isotope effects in solution. In this Account we present some highlights of our research in this area.

Preparation and Reactions

We prepared most of the enols by addition of an organometallic reagent (aryllithium or Grignard) to a diarylketene⁹ or by LiAlH_4 reduction of it (eq 1)¹⁰ or by 1,4-addition to an enone. In contrast with con-

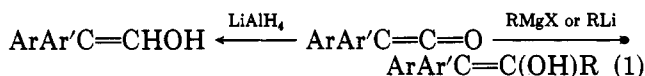

R = alkyl, aryl

ventional wisdom, in some cases the more convenient way involved the synthesis of the corresponding ketone followed by its base- or acid-catalyzed 1)¹⁰ or by 1,4-

(9) Interestingly, in contrast with less substituted analogues, these hindered ketenes are relatively unreactive and can be handled without special precautions. For example, the solid-state structure of two crowded ketenes were determined (Biali, S. E.; Gozin, M.; Rappoport, Z. *J. Phys. Org. Chem.*, in press).

(10) Biali, S. E.; Rappoport, Z. *J. Am. Chem. Soc.* 1984, 106, 5641.

addition to an enone. By these methods the series of enols 7–9 were synthesized.

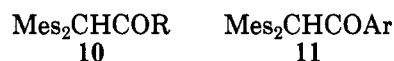
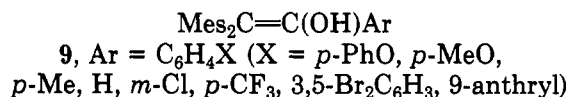
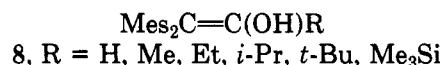
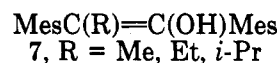

The OH group in most enols could be easily derivatized, either by direct reaction or indirectly via the enolate. In this way enol ethers,^{11,12} acetates,¹¹ or tosylates¹³ could be prepared. Also, the OH group could be replaced by a Cl group by treatment of 1 with SOCl_2 /pyridine.¹⁴

The keto forms of most of the enols, e.g., 10 and 11, were prepared by conventional methods (e.g., by Friedel–Crafts acylation of the corresponding aryl ring or, when possible, by ketonization of the enol). Ketone 4 and aldehyde 5 represented particular challenges due to past failures in their preparation. It is an ironic twist that the enol forms were readily available while the keto forms resisted all past synthetic attempts. The first evidence for the existence of 4 came from the work of Hart and Guigere, who suggested that the product from the photochemistry of 1 was derived from 4.¹⁵ We succeeded in synthesizing both 4 and 5 by using the neutral oxidant pyridinium dichromate (PDC) according to eq 2.¹⁶ The last two steps (ArLi addition followed by PDC oxidation) were also applied for the synthesis of several other 1-aryl-2,2-dimesitylethanones (11).¹⁷

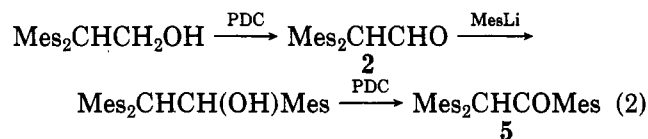

Gas-Phase Behavior of Ionized Enols and Ketones

Before our work, in studies of tautomerism of ionized keto–enol species in the gas phase, the enol ion was usually produced as a fragment by dissociative ionization (i.e., McLafferty rearrangement) rather than by direct ionization of an enol molecule.¹⁸ The availability of stable simple enols enabled us to ionize both enol and keto forms directly in the gas phase and hence to determine directly the relative heats of formation of the ions and their unimolecular reactions. We found that

(11) Biali, S. E.; Rappoport, Z. *J. Am. Chem. Soc.* 1984, 106, 477.

(12) Uggerud, E.; Drewello, T.; Schwarz, H.; Nadler, E. B.; Biali, S. E.; Rappoport, Z. *Int. J. Mass Spectrom. Ion Processes* 1986, 71, 287.

(13) Biali, S. E.; Rappoport, Z., unpublished results.

(14) Biali, S. E.; Rappoport, Z. *J. Org. Chem.* 1986, 51, 964.

(15) Hart, H.; Guigere, R. *J. Am. Chem. Soc.* 1983, 105, 7775. The assumption that 4 is an intermediate in the photochemistry of 1 was confirmed when an authentic sample of 4 was irradiated and the same photoproducts were obtained. See: Hart, H.; Lin, L.-T. W. *Tetrahedron Lett.* 1985, 26, 575.

(16) Biali, S. E.; Rappoport, Z. *J. Am. Chem. Soc.* 1985, 107, 1007.

(17) Nadler, E. B.; Rappoport, Z. *J. Am. Chem. Soc.* 1987, 109, 2112.

(18) See, for example: McAdoo, D. J.; Witiak, D. N.; McLafferty, F. W.; Dill, J. D. *J. Am. Chem. Soc.* 1978, 100, 6639.

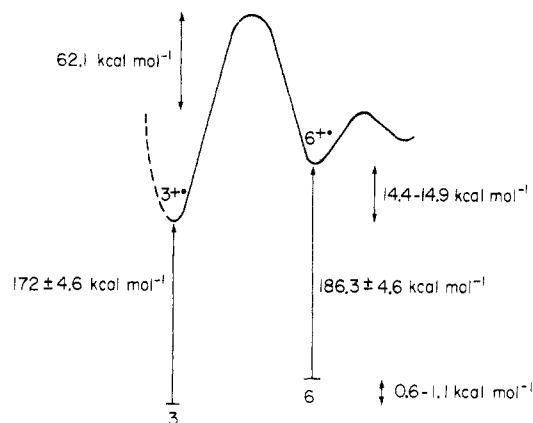
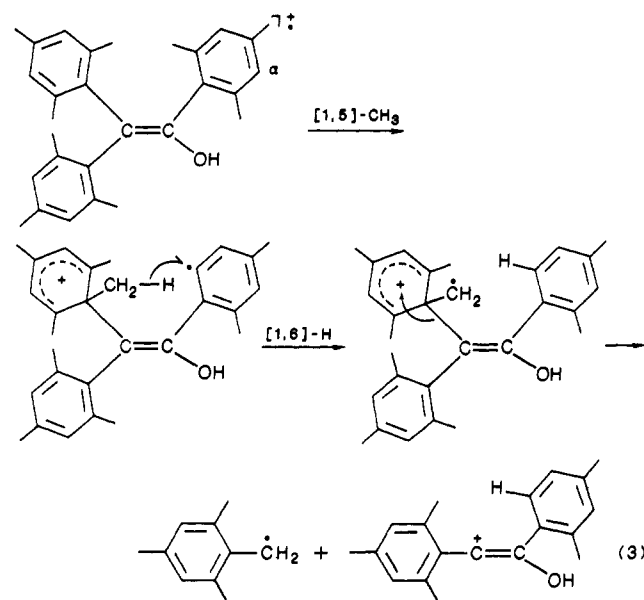

Figure 2. Schematic potential energy profile for the ketone and enol cation radicals 6^{**} and 3^{**} and their dissociation products.

the ionization potential of ketone **6** is $13.8 \text{ kcal mol}^{-1}$ higher than that of enol **3**.¹⁹ The enthalpy difference of the neutrals was estimated from the equilibria between **3** and **6** in hexane and led to the conclusion that the enol ion 3^{**} is more stable than the keto form 6^{**} by $14.4\text{--}14.5 \text{ kcal mol}^{-1}$, a value consistent with previous observations of enol/keto pairs.²⁰ This difference was further corroborated by the adiabatic ionization energies calculated from the $\text{He(I}\alpha)$ photoelectron spectrum.²¹ In addition, appearance energies were determined from the metastable ion transition $356^{**} \rightarrow 147^+$ in order to evaluate the activation energy difference (ΔE_a) between the enol and ketone dissociation. This enabled us to construct the profile depicted in Figure 2. Comparison of the kinetic energy release ($T_{1/2}$) of the metastable ion transition $356^{**} \rightarrow 147^+$ of the species formed by cleavage of the (*E*)- and (*Z*)-enol acetates of **3** with the different $T_{1/2}$ values of directly ionized **3** and **6** showed the ion derived from the two enol acetates to be identical with the ion derived from the enol **3**. Consequently, the molecular ions of enol acetates undergo loss of the CH_2CO fragment through a four-center transition state leading to an enol and not through a six-center transition state leading to a ketone. A similar four-membered transition state leading to enol **1** rather than to ketone **4** for vinyl ether cleavage was deduced from the fragmentation of trimesitylvinyl isopropyl ether labeled at the isopropyl groups.¹² The $\Delta T_{1/2} = T_{1/2}(\mathbf{9}) - T_{1/2}(\mathbf{11})$ values for six 9/11 pairs cannot be correlated with the substituent constants of the α -aryl substituents. The keto/enol pairs can be distinguished by small, but significant differences in the collisional activation mass spectra.¹² Different ions are also formed in the mass spectra of the 2/5 pair, and a study of labeled isotopomers, $T_{1/2}$ values, and ionization and appearance energies revealed reciprocal methyl/hydrogen migration and enabled the construction of a potential energy profile for this system.²²

An unusual fragmentation was found in the mass spectra of enol **1**. The molecular ion 1^{**} eliminates a $\text{C}_{10}\text{H}_{13}^{\bullet}$ fragment (presumably a 2,4,6-trimethylbenzyl radical), a unit not present in **1** and which therefore

cannot split off directly.²³ The study of analogues and deuterium-labeled isotopomers showed that the rearrangement involves the migration of a Me group from the ortho position of an α -ring (the "donor") to the ipso position on a β -ring cis to it (the "acceptor"), followed by a hydrogen transfer from the methyl that migrated to the α -ring and fragmentation (eq 3).²³ The migration



of the methyl group is probably conformationally controlled, being facilitated by the proximity of the migration origin and terminus in the preferred propeller conformation (see below) of **1**. Interestingly, the isomeric ketones also show the reciprocal methyl/hydrogen migration but hydrogen exchange between the different rings precedes the dissociation.²⁴

Ion mobility spectrometry/mass spectrometry (IMS/MS) techniques showed again that the ionized species formed from the 3/6 and the 9/11 ($\text{Ar} = \text{Ph}$) pairs retain their identity in the gas phase, although the mobilities of the ions are very similar.²⁵

Solid-State Structures

The structures of several triaryl- and 2,2-dimesityl-1-alkylethenols and their keto counterparts were determined by X-ray crystallography.^{17,26,27} All the diaryl- and triarylethenols studied exist in the solid state in a propeller^{28,29} conformation in which the aryl rings are all twisted in the same sense. This arrangement represents a low-energy conformation as shown by molecular mechanics (MM) calculations.^{30,31} The absolute value of the twist angle is dependent on the steric requirements of the rings. For **1** the twist angles are $52\text{--}56^\circ$.²⁶ For **9** ($\text{Ar} = \text{Ph}$), the twist angles of the

(23) Biali, S. E.; Depke, G.; Rappoport, Z.; Schwarz, H. *J. Am. Chem. Soc.* **1984**, *106*, 496.

(24) Biali, S. E.; Rappoport, Z.; Depke, G.; Eckart, K.; Schwarz, H. *Int. J. Mass Spectrom. Ion Processes* **1985**, *63*, 289.

(25) Karpas, Z.; Stimac, R. M.; Rappoport, Z. *Int. J. Mass Spectrom. Ion Processes* **1988**, *83*, 163.

(26) Kaftory, M.; Biali, S. E.; Rappoport, Z. *J. Am. Chem. Soc.* **1985**, *107*, 1701.

(27) Kaftory, M.; Nugiel, D. A.; Biali, S. E.; Rappoport, Z., unpublished results.

(28) (a) Mislow, K.; Gust, D.; Finocchiaro, P.; Boettcher, R. *J. Fortschr. Chem. Forsch.* **1974**, *47*, 1. (b) Willem, R.; Gielen, M.; Hoogzand, C.; Pepermans, H. In *Advances in Dynamic Stereochemistry*; Gielen, M., Ed.; Freund: London, 1985; Vol. 1, p 207.

(29) Meurer, K. P.; Vögtle, F. *Top. Curr. Chem.* **1985**, *127*, 1.

(19) Biali, S. E.; Lifshitz, C.; Rappoport, Z.; Karni, M.; Mandelbaum, A. *J. Am. Chem. Soc.* **1981**, *103*, 2896.

(20) Holmes, J. L.; Lossing, F. P. *J. Am. Chem. Soc.* **1980**, *102*, 1591.

(21) Lecoultrre, J.; Heilbronner, E.; Biali, S. E.; Rappoport, Z. *Helv. Chim. Acta* **1986**, *69*, 2108.

(22) Rabin, I.; Biali, S. E.; Rappoport, Z.; Lifshitz, C. *Int. J. Mass Spectrom. Ion Processes* **1986**, *70*, 301.

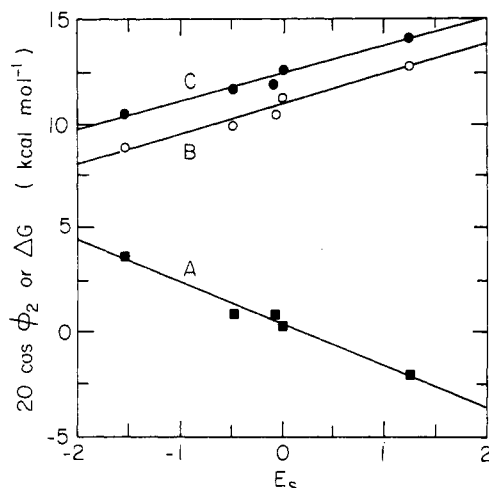
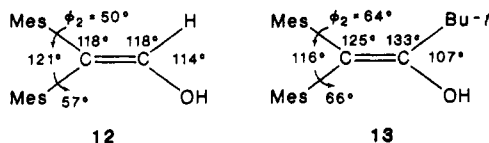

Figure 3. Correlation of cosine of the torsional angles ϕ_2 (B), keto-enol free energy difference (ΔG°) (A), and rotational barriers for the two-ring flip process (ΔG_c^\ddagger) (C) of **8** (R = H, Me, Et, *i*-Pr, *t*-Bu) with Taft's steric parameter E_s .

bulkier mesityl rings are 79.0° and 74.8° , whereas the angle for the phenyl ring is 33.3° . A similar trend was found in the calculated (MM) structure of **3**: the mesityl torsional angles are 74° and 67° , whereas for the phenyl ring it is only 39° .³⁰ For series **8** the torsional angles of the β' and β rings increase with the bulk of R. For example, for **8** (R = H and *t*-Bu) these angles are 56.7° , 50.2° and 66.0° , 63.7° , respectively. The increased repulsion between cis substituents on increasing the steric bulk of R is also reflected in the opening of the R—C=C and β -Mes—C=C angles while the R—C—O angle is reduced (cf. **12** and **13**).²⁷ Linear



correlations exist between the R—C=C bond angles or the β -Mes—C=C dihedral angles ϕ_2 or their cosine (Figure 3) of enols **8** (R = H, Me, Et, *i*-Pr, *t*-Bu) and Taft's steric parameter E_s of the R substituent.³¹

The C=C bond lengths ranged from 1.343 (**7**) to 1.362 (**7**) Å and also showed an elongation with the increase of steric crowding.^{26,27} When the enols crystallized without solvent of crystallization, they exist in a syn conformation (see below) (with the exception of **2**, which exists unsolvated but in an anti-type conformation) whereas **9** (Ar = 9-anthryl) crystallized in an antiperiplanar conformation with a hydrogen-bonded ethanol molecule.

Keto-Enol Equilibria

Having both the enols and their keto isomers enabled us to determine accurate keto-enol equilibrium constants K_{enol} (eq 4) by direct equilibration, thus avoiding the conventional assumptions used in obtaining K_{enol} values.³²

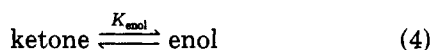

(30) Biali, S. E.; Meyer, A. Y.; Rappoport, Z.; Yuh, Y. H. *J. Org. Chem.* **1985**, *50*, 3918.

(31) Biali, S. E.; Nugiel, D. A.; Rappoport, Z. *J. Am. Chem. Soc.*, in press.

(32) For a review, see: Toulllec, J. *Adv. Phys. Org. Chem.* **1982**, *18*, 1.

The equilibrations were carried out at 353.6–367.6 K in hexane starting from both sides. The equilibration rates were usually low even in the presence of a catalytic amount of CF_3COOH , and it took several hours to days to achieve complete equilibration. K_{enol} values were measured for four different structural types. The shortest series include enol/keto pairs **1/4** and **9/11** (Ar = Ph), for which K_{enol} values were 79 ± 7 at 353.6 K and 1.02 ± 0.07 at 367.6 K (i.e., ΔG° 's of -3.1 ± 0.3 and -0.01 ± 0.04 kcal mol⁻¹), respectively. The K_{enol} for **1/4** is the highest known for either a simple aldehyde or ketone. It is noteworthy that in determining K_{enol} the usual analytical problem is to detect *low enol concentrations* but here it is replaced by a need for accurate determination of a *low ketone concentration* at equilibrium. The much higher K_{enol} value for the bulkier α -aryl group supports the intuitive feeling that the enols derive their stability mainly from the steric bulk of the aryl substituent.

However, that this is an oversimplification is shown by the K_{enol} values at 353.6 K for the series **8/10**, which range from 20 ± 1 for **2/5** to 0.006 ± 0.0005 for the α -*tert*-butyl derivatives (**8/10**, R = *t*-Bu). The ΔG° values, which encompass 5.7 kcal mol⁻¹, are linear in Taft's E_s values with a slope of -1.5 (Figure 3);³³ i.e., K_{enol} values *decrease* rather than increase as the bulk of the α -alkyl substituent increases.³³ Moreover, **2**, which is much less crowded than enols **9**, has a much higher K_{enol} value. For **8** (R = SiMe₃) the K_{enol} value is ≥ 20 , i.e., higher than for any of the aforementioned α -alkyl-substituted enols.³⁴ This was ascribed to a preferential electronic destabilization of the keto form due to the low electronegativity of silicon compared with carbon. Consequently, polar and resonance effects, which distinguish α -alkyl and α -aryl groups, should be important. A more quantitative evaluation of these contributions is given by the correlation between the log K_{enol} values and the σ^+ values of the α -aryl substituent ($\rho^+ = 0.65$) for series **9/11**.¹⁷ The analysis suggests that the positive ρ^+ is mainly determined by relative resonance stabilization of ketones with electron-donating aryl groups rather than by substituent effects on the enols. Finally, K_{enol} for the **3/6** pair does not differ much from that for the isomeric **9/11** (Ar = Ph) pair. Unfortunately, comparison of K_{enol} values of isomeric enols **7** and **8** is not yet possible since we have difficulties in the determination of the K_{enol} values of **7** due to their high sensitivity to oxidation and their decomposition during attempted equilibration.³⁵

These results suggest that whereas the kinetic stability of the enols is probably mainly due to steric hindrance in formation of the transition states of the isomerization, the relatively high thermodynamic stabilities are due to a complex interplay of polar, resonance, hyperconjugation, steric, and hydrogen-bonding effects in both the enols and the ketones. For example, Ar—C=C conjugation of the two β -aryl groups should decrease ΔG° of eq 4 by several kcal mol⁻¹ even when the Ar—C=C dihedral angles are relatively large, since the ketone lacks such stabilization. The enol stability should increase on reducing the dihedral angles; hence, steric bulk at C $_{\beta}$ should reduce K_{enol} due to this factor.

(33) Nugiel, D. A.; Rappoport, Z. *J. Am. Chem. Soc.* **1985**, *107*, 3669.

(34) Nadler, E. B.; Rappoport, Z.; Arad, D.; Apeloig, Y. *J. Am. Chem. Soc.* **1987**, *109*, 7873.

(35) Nadler, E. B., unpublished results.

However, attempts to prepare $\text{Ph}_2\text{C}=\text{C}(\text{OH})\text{Ar}$ ($\text{Ar} = \text{Mes}$, 2,4,6-*i*- $\text{Pr}_3\text{C}_6\text{H}_2$) gave only the ketone,³⁶ but K_{enol} for $\text{Ph}_2\text{C}=\text{CHOH}$ in water is already 0.1.⁴ On the other hand, enforced planarity of the β -phenyl groups increases K_{enol} in water to 0.005^{37a} and to 17^{37b} for **14** ($\text{R} = \text{Me}$ and H), respectively. Since an $\text{Ar}-\text{C}=\text{O}$ in-

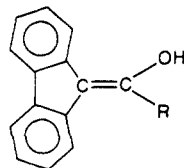

14

teraction is more stabilizing than an $\text{Ar}-\text{C}=\text{C}$ interaction, replacement of an α -hydrogen by an α -aryl ring should stabilize the keto form more than the enol. The corresponding reduction in K_{enol} will be smaller the bulkier is the α -aryl. This effect partially accounts for the high K_{enol} for **2**, **14** ($\text{R} = \text{H}$), and $\text{Ph}_2\text{C}=\text{CHOH}$ and probably contributes to the positive deviation of α -Mes from the $\log K_{\text{enol}}$ vs σ^+ plot, but in this case other steric interactions in **1** and **4** are also important. Likewise, polar and hyperconjugative $\text{R}-\text{C}=\text{C}$ and $\text{R}-\text{C}=\text{O}$ stabilizations superimposed on geometrical changes reflected in **12** and **13** (and in the isomeric ketones) should be taken into account in analyzing the trends in K_{enol} for series 8/10. As shown below, intramolecular hydrogen bonding also contributes modestly to the stabilization of the enols. Consequently, at present the relative magnitude of K_{enol} values in the various series is only partly understood.

Is there a correlation between K_{enol} values for crowded and simple aliphatic enols? Surprisingly, a linear correlation between $\text{p}K_{\text{enol}}(\text{H}_2\text{C}=\text{C}(\text{OH})\text{R})$ and $\text{p}K_{\text{enol}}(\text{Mes}_2\text{C}=\text{C}(\text{OH})\text{R})$ for the five enols for which data were available was found in 1987.³⁸ However, the correlation deteriorates when recent newly determined K_{enol} values of aliphatic enols are added.³⁹

Conformation of the $\text{C}=\text{C}-\text{OH}$ Moiety and Interactions of the OH Group with the Solvent

A combination of NMR and IR techniques enabled determination of the conformation of the $\text{C}=\text{C}-\text{OH}$ moiety in various media and identification of the interactions that lead to the most stable conformation.

MO calculations on the parent vinyl alcohol⁴⁰ as well as MM calculations on enols **2** and **8**¹³ indicate that an isolated enol molecule in the gas phase prefers a syn conformation for the $\text{C}=\text{C}-\text{OH}$ moiety. As discussed above, the solid-state conformation of **1** is synperiplanar whereas intermolecular hydrogen bonding in the crystal of $\text{Mes}_2\text{C}=\text{C}(\text{OH})(9\text{-anthryl})\cdot\text{EtOH}$ ²⁶ and of **2**²⁷ resulted in preferred antiperiplanar conformations.

When the ¹H NMR spectra of **2** were measured in 14 solvents of diverse properties, very large changes in both the chemical shift of the sharp OH signal ($\delta(\text{OH})$) and in the coupling constant of the HCOH doublet (³*J*-

(HCOH)) were observed. Typical examples are $\delta(\text{OH})$ values of 4.47, 6.22, 7.65, 9.01, and 9.17 ppm and the accompanying ³*J*(HCOH) values of 14.1, 8.6, 8.2, 5.9, and 4.6 Hz in CCl_4 , CD_3CN , $(\text{CD}_3)_2\text{CO}$, $(\text{CD}_3)_2\text{SO}$, and $\text{DCON}(\text{CD}_3)_2$, respectively.¹⁰ The $\delta(\text{OH})$ values of the various enols are linearly correlated with one another, and ³*J*(HCOH) and $\delta(\text{OH})$ for **2** were approximately linearly correlated. A correlation of the $\delta(\text{OH})$ values with the Kamlet-Taft complete solvatochromic equation⁴¹ showed that the best linear correlation is with β , the hydrogen bond accepting parameter of the medium. Similar correlations were observed for other enols.^{10,42,43} Hence the main interaction with the solvent is identified as an enol-solvent hydrogen bonding.

Direct conformational information was deduced from the ³*J*(HCOH) values of **2**. The changes in these values with the solvent are the highest known for such *J*'s. Since nonconformational solvent effects on ³*J* are usually regarded as minor, the use of eq 5, which relates ³*J*(HCOH) = 10.4 cos² θ - 1.5 cos θ + 0.2 (in Hz) (5)

the observed ³*J*(HCOH) values to the $\text{C}=\text{C}-\text{OH}$ dihedral angle,⁴⁴ led to the following conclusions: In CCl_4 , where ³*J*(HCOH) is higher than the maximum predicted by eq 5, the conformation is synperiplanar (**15**).



15

16

Planar and periplanar conformations also prevail in other nonpolar solvents (S) with low hydrogen bond accepting abilities, such as CDCl_3 or $\text{C}_6\text{D}_5\text{X}$ ($\text{X} = \text{D}$, Br, CD_3). In solvents S with high hydrogen bond accepting abilities such as $\text{DMSO}-d_6$ or $\text{DMF}-d_7$, the conformation is anticlinal (**16**) with a $\text{C}=\text{C}-\text{OH}$ dihedral angle $< 150^\circ$. In solvents S with moderate hydrogen bond accepting ability, e.g., acetone or acetonitrile, conformers **15** and **16** exist in a rapid equilibrium with appreciable populations.

The stability of the most hindered synplanar conformation in non-hydrogen bond accepting solvents is ascribed to the presence of stabilizing intramolecular hydrogen bonding between the OH and the π system of the ring cis to it. Indeed, the ν_{OH} of 3500 cm^{-1} in CCl_4 indicates a hydrogen bond interaction, whereas the appearance of a peak with 2% of the intensity at 3630 cm^{-1} is ascribed to a free OH, in a presumably anti-type conformation. The correlation with Kamlet-Taft's β suggests that the dominant role of the solvent is to replace this interaction in the syn conformer by a stronger intermolecular hydrogen bonding as depicted in **16**, and the accompanying syn \rightarrow anti conformational change reduces the steric hindrance to such bonding. Consequently, in the hydrogen bond accepting solvents ν_{OH} of **15** is at lower wavenumbers. A confirmation for these conclusions comes from the study of the $\Delta\delta(\text{OH})$ of isotomers **17a/17b** ($\text{Mes}^* = 2,4,6\text{-(CD}_3)_3\text{C}_6\text{H}_2$) in seven solvents. $\Delta\delta(\text{OH}) = 7.2\text{--}11.6$ ppb in solvents where the conformation of **2** is **15** and 0 in $\text{DMSO}-d_6$

(36) Nugiel, D. A., unpublished results.

(37) (a) Argile, A.; Carey, A. R. E.; Fukata, G.; Harcourt, M.; More O'Ferrall, R. A.; Murphy, M. G. *Isr. J. Chem.* 1985, 26, 303. (b) Harcourt, M. P.; More O'Ferrall, R. A. *J. Chem. Soc., Chem. Commun.* 1987, 822.

(38) Rappoport, Z. *J. Am. Chem. Soc.* 1987, 109, 4730.

(39) Keefe, J. R.; Kresge, A. J.; Schepp, N. P. *J. Am. Chem. Soc.* 1988, 110, 1993.

(40) Nobes, R. H.; Radom, L.; Allinger, N. L. *J. Mol. Struct.* 1981, 85, 185.

(41) Kamlet, M. J.; Abboud, J. L. M.; Taft, R. W. *Prog. Phys. Org. Chem.* 1981, 13, 485.

(42) Nadler, E. B.; Rappoport, Z. *J. Am. Chem. Soc.*, in press.

(43) Rappoport, Z.; Nugiel, D. A.; Biali, S. E. *J. Org. Chem.*, in press.

(44) Fraser, R. R.; Kaufman, M.; Morand, P.; Govil, G. *Can. J. Chem.* 1969, 47, 403.

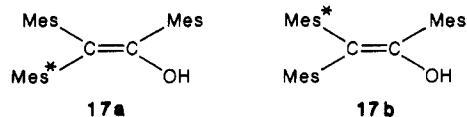

when it is 16. This difference is consistent with a maximal interaction of the OH with the labeled or the nonlabeled β' -mesityl in a conformation such as 15, whereas it becomes negligible in an anti-type conformation such as 16, which is present in DMSO- d_6 .¹⁰

Both IR and NMR give similar values of 15:16 ratios at equilibrium in solvents of moderate hydrogen bond accepting ability. The correlations between $^3J(\text{HCOH})$ and $\delta(\text{OH})$ for 2 and between the $\delta(\text{OH})$ values of 2 and $\delta(\text{OH})$ of other enols suggest that similar conclusions regarding the preferred conformations are applicable for the other enols.

Addition of small amounts of DMF- d_7 or DMSO- d_6 to solutions of all the enols in CCl_4 results in a large change in $\delta(\text{OH})$ (or in $^3J(\text{HCOH})$ for 2) whereas on further addition of the cosolvent the changes become moderate. These changes were analyzed in terms of an equilibrium between an internally hydrogen-bonded conformation and an intermolecular bonded conformation to a single solvent molecule as exemplified for 2 in eq 6. The K_{ass} values calculated for compound 8



in DMSO are 5.25, 1.38, 1.04, 0.70, and 0.47 for R = H, Me, Et, *i*-Pr, and *t*-Bu. The $\log K_{\text{ass}}$ values for 8-DMSO are linear in Taft's σ^* values,⁴³ and for compound 9 $\log K_{\text{ass}}$ values are linear in σ ($\rho = 0.35$).⁴² The dependence on the polarity rather than on the bulk of the α -substituent presumably reflects the interaction with the hydrogen bond accepting solvent at the relatively unhindered side of the enol molecules.⁴²

A similar study of 2 in CCl_4 -solvent mixtures gave K_{ass} values for other 1:1 enol-solvent association complexes. The $\log K_{\text{ass}}$ values were roughly linear with the β -parameters of the solvent. From $^3J(\text{HCOH})$ values for the associated conformer in these solvents the C=C—OH dihedral angle is not constant, but increases with increase in β of the solvent.⁴²

Static and Dynamic Stereochemistry of Crowded Di- and Triarylethenols

The dynamic behaviors of the crowded triarylethenol 1 and its 1-(9-anthryl) analogue and of the diarylethenols 8 (R = H, Me, Et, *i*-Pr, *t*-Bu) were chosen for detailed study. As discussed above, these enols exist in the solid in a chiral "propeller" conformation in which all the rings are twisted in the same sense (Figure 4). Such conformation is chiral (C_1 symmetry), and therefore the enols exist in two enantiomeric forms.

The NMR of 1 at 300 MHz in $\text{C}_6\text{D}_5\text{NO}_2$ at room temperature (Figure 1) is in agreement with a frozen (on the NMR time scale) propeller conformation. The diastereotopicity or constitutional heterotopicity of the different groups results in the appearance of a separate signal for each methyl or aromatic proton.¹¹ By means of isotopic labeling, comparison with analogues of 1, the use of the saturation transfer technique, long-range couplings, and NOE effects a full assignment of the NMR signals of 1 could be made.^{11,45} When the tem-

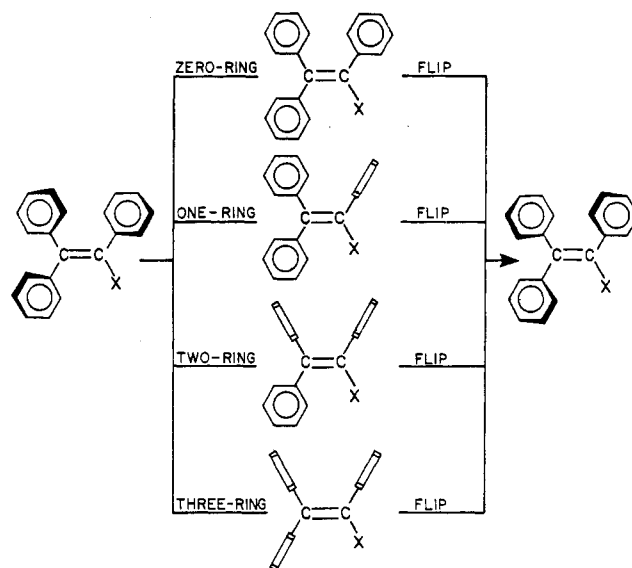
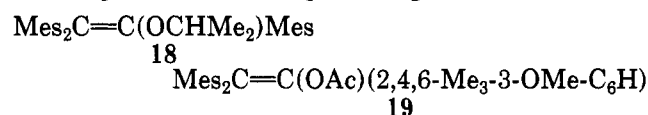

Figure 4. Examples of the various transition states for the flip mechanisms interconverting the enantiomeric conformations of a three-bladed vinyl propeller. Rings perpendicular to the C=C plane are shown by rectangles.

perature was raised different signals broadened and eventually coalesced. The calculated barriers for the exchange of the methyls or the aromatic groups at each ring gave identical values within experimental error ($\Delta G_c^\ddagger = 18.4 \pm 0.1 \text{ kcal mol}^{-1}$), and these barriers were unaffected by a change of solvent or by the addition of CF_3COOH . It was concluded therefore that the dynamic process followed involves neither ionization nor ketonization-reenolization but corresponds to a rotational process. The similarity of the rotational barriers probed at the different rings points to a single correlated rotation of the rings. This conclusion is corroborated by similar results obtained for the 1-(9-anthryl) analogue and for derivatives of 1 (i.e., the acetate and the chloride).¹¹ In principle, two different types of correlated rotation mechanisms can be envisioned: the first involves helicity reversal (generally known as "flip mechanisms")⁴⁶ and the second retains the helicity (i.e., resulting in a rotation of each ring by 180°). In the flip mechanisms the ring(s) that "flip" pass through a plane perpendicular to the double bond plane whereas the nonflipping rings pass through the double-bond plane. Depending on the number of flipping rings these mechanisms are called zero-, one-, two-, or three-ring flip. Examples of the hypothetical transition states for the flip mechanisms are shown in Figure 4.

The nonflip mechanisms were excluded by means of the isopropyl ether derivative 18. In the slow-exchange NMR spectrum of 18, separate signals were observed



for the aromatic methyls and protons and for the isopropyl methyls. The diastereotopicity of the isopropyl methyls supports a chiral propeller conformation for 17 in solution. Identical barriers ($15.8 \pm 0.1 \text{ kcal mol}^{-1}$) were calculated for the rotation of the rings from the coalescence of pairs of aromatic signals as well as for

(45) Biali, S. E.; Rappoport, Z.; Hull, W. H. *J. Am. Chem. Soc.* 1985, 107, 5450.

(46) (a) Kurland, R. J.; Schuster, I. I.; Colter, A. K. *J. Am. Chem. Soc.* 1965, 87, 2279. (b) Gust, D.; Mislow, K. *J. Am. Chem. Soc.* 1973, 95, 1535.

the enantiomerization process from the coalescence of the isopropyl methyls. This identity indicates that the rotational mechanism monitored is a flip mechanism and we concluded that it is a three-ring flip mechanism. To the best of our knowledge, **1** represents the first example of a triaryl molecular propeller in which the rotational mechanism of lowest activation energy (threshold mechanism) is a three-ring flip.⁴⁷ In both **1** and **18** the neighboring cis mesityl or OR (R = H, *i*-Pr) group hinders the passage of a given ring through the double-bond plane, causing the three-ring flip to become the least hindered flip mechanism. However, if the OH group is replaced by a hydrogen, the passage of the ring cis to it through the C=C plane becomes so much less hindered that the [α,β] two-ring flip becomes the threshold mechanism.⁴⁸ Similarly, for enols **8** (R = Me, Et, *i*-Pr, *t*-Bu) both DNMR and MM calculations indicate the [β,β'] two-ring flip as the threshold mechanism whereas for **2** it is the [β] one-ring flip.^{31,49} These represent the first examples of a substituent-dependent shift in threshold mechanism of a molecular propeller. The barriers for the two-ring flip for **8** (14.2, 12.5, 12.0, 11.7, and 10.4 kcal mol⁻¹ for R = H, Me, Et, *i*-Pr, *t*-Bu, respectively) are linearly correlated with Taft's E_s values (Figure 3)³¹ and hence with the dihedral angles ϕ_2 . Consequently, higher ground-state energy results in a lower barrier.

The relatively low enantiomerization barrier of **1** precludes its resolution on the laboratory time scale at room temperature. However, since the edges of the mesityl rings do not exchange sides by the threshold rotational mechanism if one of the mesityl rings is substituted at the meta position, the compound should exist in two (residual)⁵⁰ enantiomeric forms *under the full operation of the three-ring flip*. Indeed, derivative **19** can be resolved into two enantiomeric forms.⁵¹

Steric Isotope Effects in Isotopomeric Enols

Steric isotope effects (SIE) arise from the different "size" of isotopic atoms.⁵² The shorter C-D compared with a C-H bond is reflected in both kinetic and equilibrium SIE's.⁵³ The determination of a SIE requires high accuracy since characteristic effects are small. Recent advances in NMR instrumentation enabled the determination of the "conformational SIE" by the chemical shift of the signals⁵⁴ and recently also by direct integration of the NMR signals.⁵⁵

The chemical shift of the OH group of **1** is a sensitive probe of the β' mesityl ring environment (see above). We synthesized a ca. 1:1 ratio of the isotopomers of **1** (**17a/17b**) and the doubly labeled **20a/20b** by addition

of MesMgBr and Mes*¹³C₆H₄MgBr to Mes*(Mes)C=C=O (e.g., eq 7).

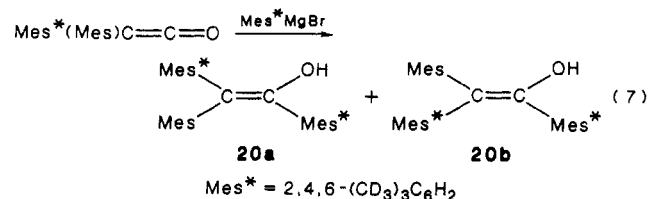

For each isotopomeric mixture (**17a/17b** or **20a/20b**) two signals were displayed for the OH group in the ¹H NMR spectrum, presumably due to slightly different torsional angles of the rings resulting from the presence of a SIE in each isotopomeric pair. By means of Lorentz-Gaussian line-shape transformation the small base peak overlap between the two signals was completely removed, and repeated integrations led to reliable ratios. The *E* isomers **17b** and **20b** are present in slight excess, and the best *E/Z* ratios at 302 K of 1.026 ± 0.007 for the ratio **17b/17a** and of 1.048 ± 0.027 for **20b/20a** were ascribed to a manifestation of an equilibrium SIE. The isomer in which the Mes* group is located in the more crowded environment (cis to the α -ring) is favored over the isomer in which the bulkier Mes group is at that position. This represents a rare determination of a SIE by integration of NMR signals of isotopomers, which is especially interesting since the probes are the (usually wide) OH signals.

Solvolytic Generation of Crowded Triarylvinyl Cations

We will conclude this review with our original aim, i.e., with the generation of trimesitylvinyl cation (**21**). AgBF₄-assisted solvolysis of trimesitylvinyl chloride in EtOH yielded, in addition to ethyl trimesitylvinyl ether, which is the expected capture product, 2,3-dimesityl-4,6-dimethylindene formed by a formal cyclization on a methyl group (eq 8).¹⁴

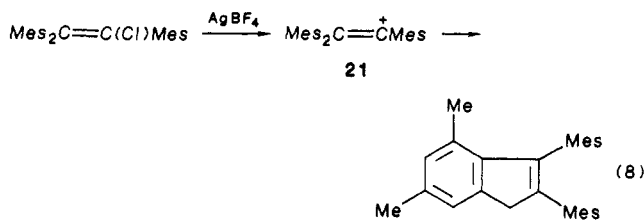

The capture by ROH is subject to steric hindrance. It is faster than cyclization for MeOH and EtOH and is slower than cyclization for the bulkier alcohols *i*-PrOH and *t*-BuOH. The intramolecular cyclization is probably facilitated by the crowdedness of the trimesitylvinyl skeleton, since when the less hindered 1,2-dimesityl-2-phenylvinyl chloride was solvolyzed, the derived vinyl cation gave only capture products and no indene formation.¹⁴

Cation **21** undergoes degenerate β -mesityl rearrangements. When the α - or β -mesityl-*Me-d*₉ labeled **1** reacts with SOCl₂ (a reaction in which **21** is most probably an intermediate), almost complete scrambling of the label at the α , β , and β' positions of the resulting trimesitylvinyl chloride was observed.¹⁴

Conclusions

The combination of a crowded polyarylvinyl skeleton and the enol functionality makes the stable simple enols

(47) Mislow, K. *Acc. Chem. Res.* 1976, 9, 26.

(48) Biali, S. E.; Rappoport, Z. *J. Org. Chem.* 1986, 51, 2245.

(49) Nugiel, D. A.; Biali, S. E.; Rappoport, Z. *J. Am. Chem. Soc.* 1984, 106, 3357.

(50) Finocchiaro, P.; Gust, D.; Mislow, K. *J. Am. Chem. Soc.* 1974, 96, 3198.

(51) Biali, S. E.; Rappoport, Z.; Mannschreck, A.; Pustet, N. *Angew. Chem.*, in press.

(52) For reviews, see: (a) Carter, R. E.; Melander, L. *Adv. Phys. Org. Chem.* 1973, 10, 1. (b) Melander, L.; Saunders, W. H. *Reaction Rates of Isotopic Molecules*; Wiley: Chichester, 1980; pp 189-199.

(53) For a classical determination of a (kinetic) SIE, see: Mislow, K.; Graeve, R.; Gordon, A. J.; Wahl, G. H. *J. Am. Chem. Soc.* 1964, 86, 1733.

(54) Anet, F. L.; Basus, V. J.; Hewett, A. P. W.; Saunders, M. J. *Am. Chem. Soc.* 1980, 102, 3945.

(55) For an earlier example of the determination of equilibrium SIE by direct integration, see: Aydin, R.; Günther, H. *Angew. Chem., Int. Ed. Engl.* 1981, 20, 985.

an interesting subject of research either as models for simpler enols or in their own right. The importance of crowding at the reaction center is reflected for example by the mutual linearity of structural parameters (bond and dihedral angles), dynamic parameters (rotational barriers of the two-ring flip), and thermodynamic parameters (the keto-enol equilibria) for enols **8** (Figure 3). Crowding in **1** leads to cyclization in the derived vinyl cation, to an unusual rearrangement in the derived ion radical in the gas phase, to another rearrangement under photochemical conditions,¹⁵ and to degenerate three-ring-flip rotations or rearrangements in the enols or the ions derived thereof. Nevertheless, steric effects alone are insufficient to account for the unusual and not completely understood thermodynamic stability of these enols, and they play a relatively minor part in their association with the solvent. Many more topics, not discussed due to lack of space, such as formation of more and less crowded enols, or of configurationally

stable *E/Z* pairs,⁵⁶ the pK_a 's of the enols, the kinetics of the keto-enol transformation, the preparation of enols of acids and esters by using related systems,⁵⁷ and the photochemistry of the enols and related ketones^{15,57,58} were investigated by others, as well by us, but mostly only in a cursory form or were not studied at all. We expect again in the future to encounter more surprises and unusual results in the study of these and related systems.

We thank Mrs. Ella Nadler, Mr. David Nugiel, and Prof. M. Kaftory for their contribution to work described in this review, the United States-Israel Binational Science Foundation (BSF) Jerusalem, Israel, who supported the work, and Professors H. Hart and P. Wagner, who collaborated on the BSF-supported work.

(56) Becker, H. D.; Anderson, K. *Tetrahedron Lett.* **1987**, *28*, 1323.

(57) O'Neill, P.; Hegarty, A. F. *J. Chem. Soc., Chem. Commun.* **1987**, 744.

(58) For recent papers of Wagner's group, see: Wagner, P. J.; Zhou, B. *J. Am. Chem. Soc.* **1988**, *110*, 611.